

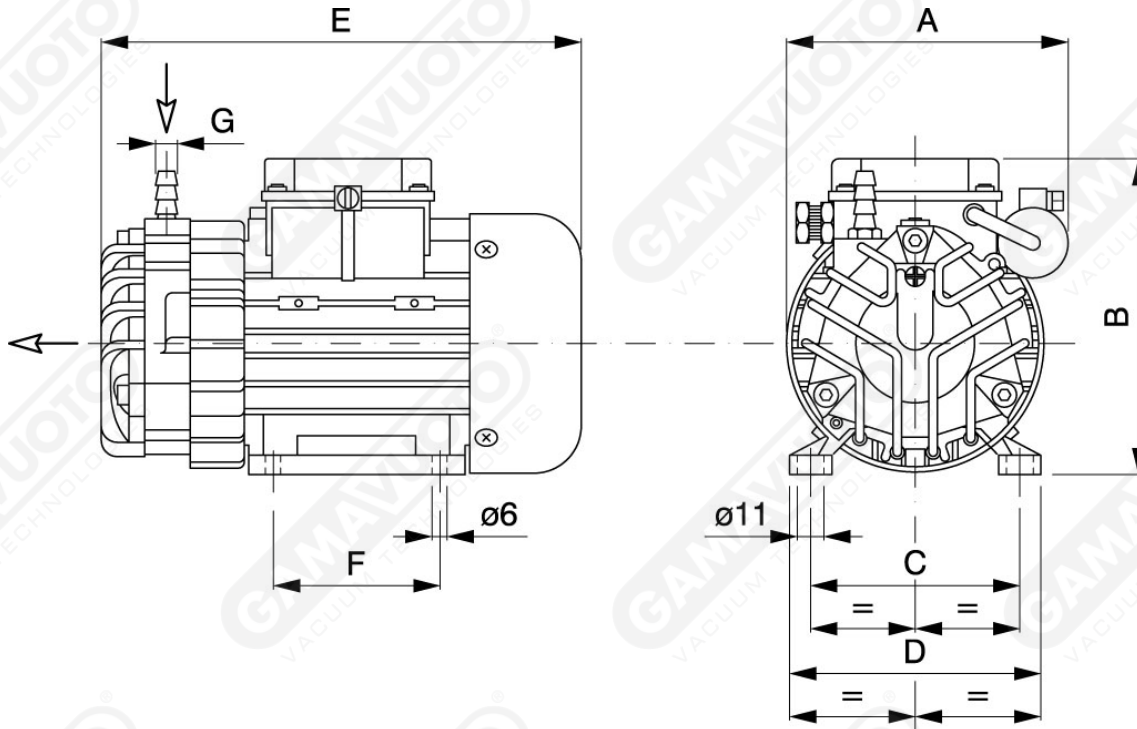

Vacuum pumps without lubrication GPZS 5



Art. GPZS 5

Art.	Vacuum flow		Final pressure ABS mbar (ass.)	Rpm		Motor power		Weight kg	A	B	C	D	E	F	G
	50 Hz Mc/h	60 Hz Mc/h		50 Hz g/min	60 Hz g/min	50 Hz Kw	60 Hz Kw								
GPZS 5	5	6	120	2800	3300	0.12	0.15	5.4	139	138	90	108	226	71	1/8"