

**Bellows suction cups VES 41 series**



VES series suction cups are designed to be the best solution for the handling of plastic bags and other materials.

They consist of two separate parts assembled together. The soft silicone lip guarantees an excellent grip on the deformable surfaces, while the body, with bellows of higher hardness, guarantees excellent resistance to stress.

In the available supports, there is the possibility to integrate a stainless steel mesh filter and the self-pressure valve for vacuum flow control.

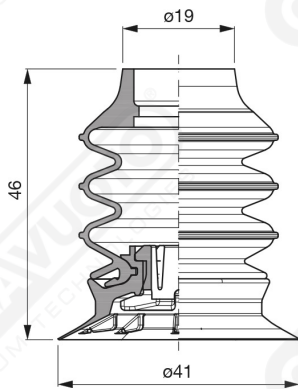

**Art. VES 41 35**

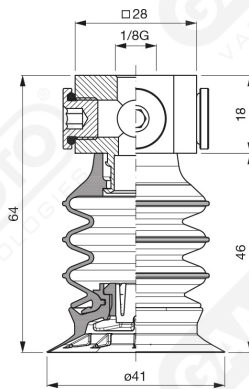

**Art. VES 41 00**

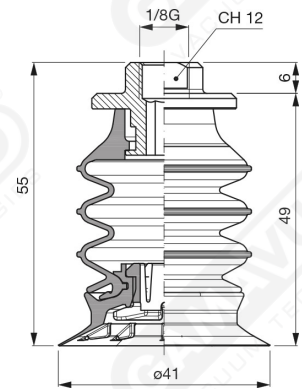

**Art. VES 41 20**

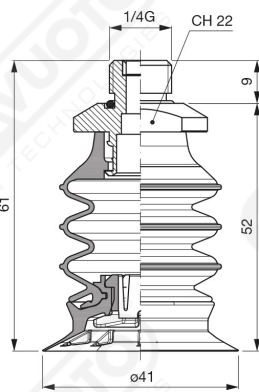

**Art. VES 41 70 ÷ 73**

**Art. VES 41 70**  
with filter

**Art. VES 41 73**  
without filter

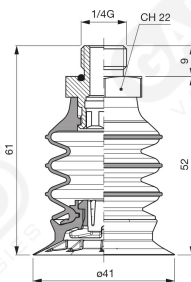

**Art. VES 41 74**

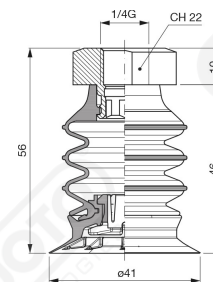

**Art. VES 41 76**

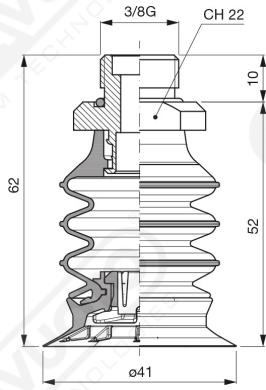

**Art. VES 41 80**  
with filter

**Art. VES 41 83**  
without filter

**Art. VES 41 80 ÷ 83**

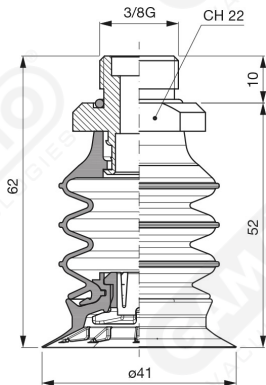

**Art. VES 41 84**

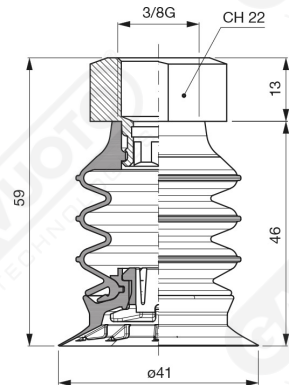

**Art. VES 41 86**

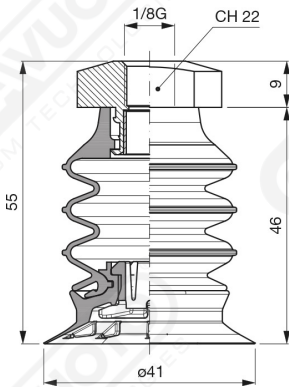

**Art. VES 41 90**  
with filter

**Art. VES 41 93**  
without filter

**Art. VES 41 90 ÷ 93**

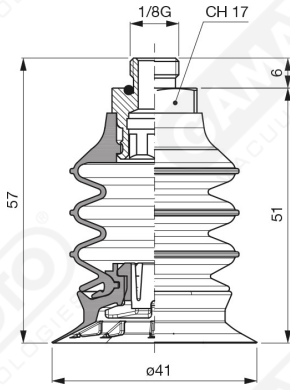

**Art. VES 41 94**

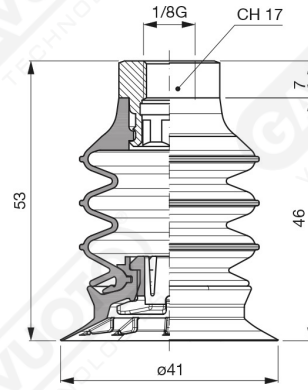

**Art. VES 41 96**