

Bellows suction cups VES 48 series



VES series suction cups are designed to be the best solution for the handling of plastic bags and other materials.

They consist of two separate parts assembled together. The soft silicone lip guarantees an excellent grip on the deformable surfaces, while the body, with bellows of higher hardness, guarantees excellent resistance to stress.

In the available supports, there is the possibility to integrate a stainless steel mesh filter and the self-pressure valve for vacuum flow control.

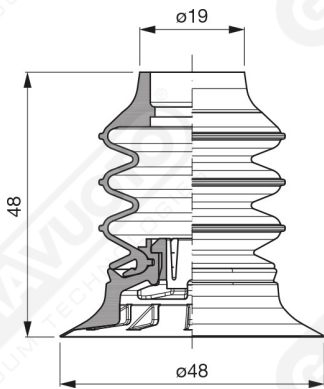

Art. VES 48 35

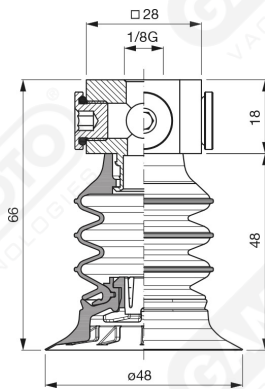

Art. VES 48 00

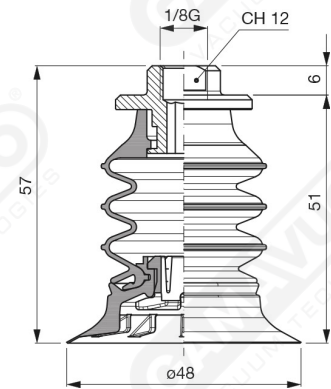

Art. VES 48 20

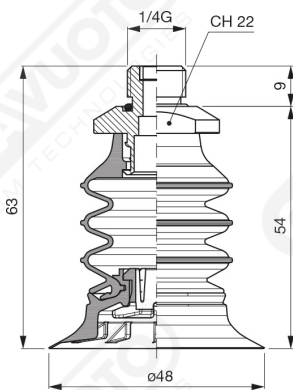

Art. VES 48 70 ÷ 73

Art. VES 48 70
with filter

Art. VES 48 73
without filter

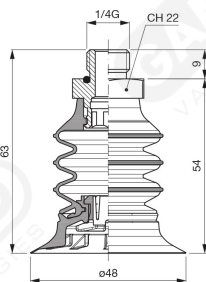

Art. VES 48 74

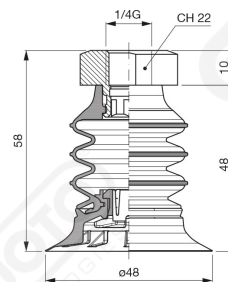

Art. VES 48 76

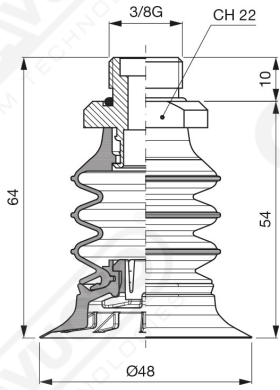

Art. VES 48 80
with filter

Art. VES 48 83
without filter

Art. VES 48 80 ÷ 83

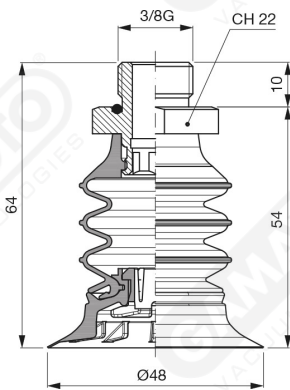

Art. VES 48 84

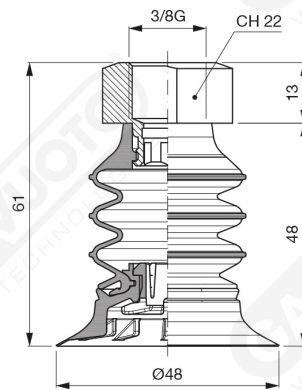

Art. VES 48 86

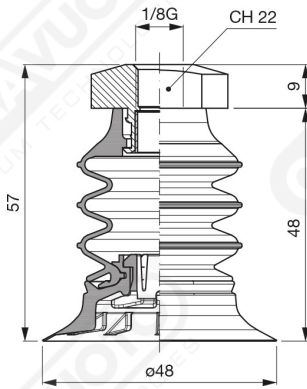

Art. VES 48 90
with filter

Art. VES 48 93
without filter

Art. VES 48 90 ÷ 93

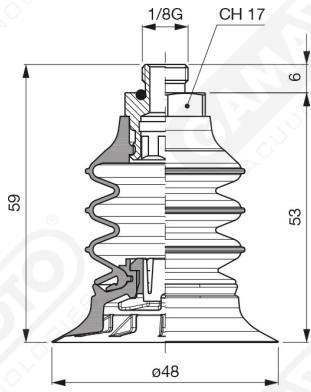

Art. VES 48 94

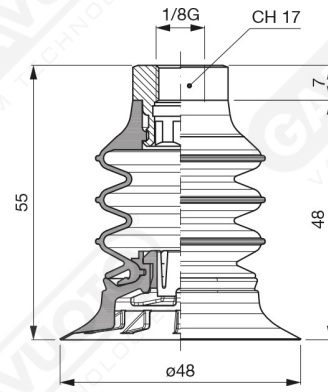

Art. VES 48 96