

**Supporti per ventose SUM**

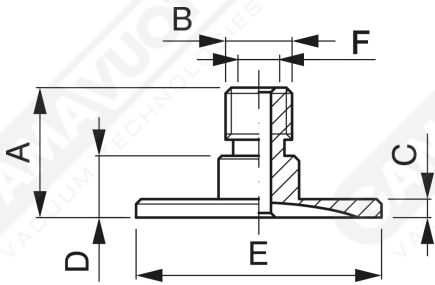

**Art. SUM  
10/11/12/13/16/17/18/22/24/25/26/  
28/34/47/48/51**

Art.	A	B	C	D	EØ	F
SUM 10	15	6 MA	1	5	12	3,15
SUM 11	15	6 MA	1	5	15	3,15
SUM 12	23	6 MA	1	12	12	3
SUM 13	23	8 MA	1	12	12	3
SUM 16	25	8 MA	1	7,8	18	3
SUM 17	33	1/4"	1	22	18	4,5
SUM 17 1/8	33	1/8"	1	22	18	4,5
SUM 18	24,5	1/4"	1	10	19	4,5
SUM 22	25	1/4"	2	10,5	24	4,5
SUM 24	39	1/4"	2,5	24,5	25	4,5
SUM 25	26,5	1/8"	3,5	12,5	34,5	4,5
SUM 26	26,5	1/4"	3,5	12,5	34,5	4,5
SUM 28	26	1/8"	4	14	49	4,5
SUM 34	32	1/4"	4	13	24	4,5
SUM 47	23,5	1/8"	1	11	19	5
SUM 48	26,5	1/4"	4	13	25	4,5
SUM 51	20	8 MA	4	8	24	4,5

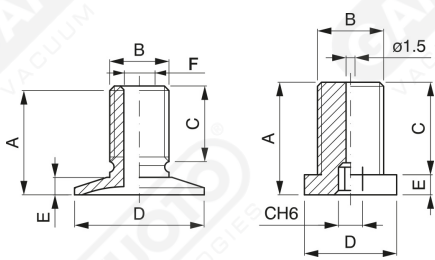

**Art. SUM 8/9/14/21/27**

Art.	A	B	C	D	E	F
SUM 8	15	8 MA	12	15	2	4,6
SUM 9	14,5	8 MA	12	12	1,5	4,7
SUM 14	15	8 MA	12	18	2,5	4,6
SUM 21	16	8 MA	12	24	2,6	4
SUM 21F2	16	8 MA	12	24	2,6	1,5
SUM 27	11,5	6 MA	8	12	1,8	3

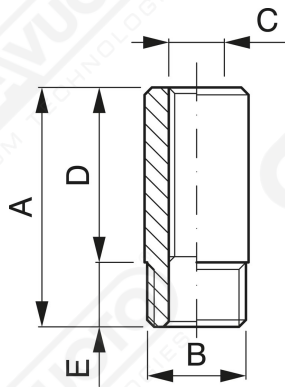

**Art. SUM 19/20**

Art.	A	B	C	D	E
SUM 19	21	1/4"	8 MA	11	10
SUM 20	30	1/4"	8 MA	20	10

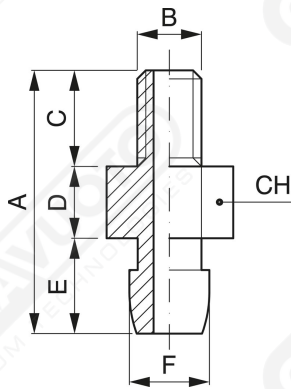

**Art. SUM 31/40/41/46/49/56**

Art.	A	B	C	D	E	FØ	CH
SUM 31	29	1/8"	6	7	16	11	13
SUM 40	13,2	5 MA	3,6	4	5,6	2,8	7
SUM 41	18	5 MA	5,5	4	8,5	5,5	8
SUM 46	12,5	5 MA	5	2	5,5	4	8
SUM 49	16	5 MA	5,5	4,5	6	5,5	8
SUM 56	29,5	1/4"	8	5	16	12	18

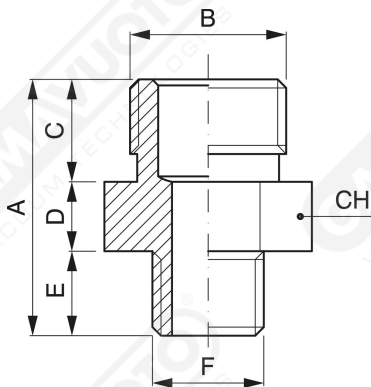

**Art. SUM 7/30/32/33/38/39/42/43/50/57**

Art.	A	B	C	D	E	F	CH
SUM 7	29,5	20X1,5	12	7,5	10	1/4"	22
SUM 30	20	1/8"	8,5	5	6,5	6 MA	13
SUM 32	36,5	1/4"	10,5	8	18	1/4"	20
SUM 33	35	12MA	16	6	13	8 MA	17
SUM 38	25	1/8"	9	5	11	1/8"	14
SUM 39	18	1/8"	5	5	8	1/8"	12
SUM 42	22	1/8"	9	5	8	8 MA	14
SUM 43	20	12	10,5	4	5,5	5 MA	14
SUM 50	25	10,5	11	5,5	9	1/8"	14
SUM 57	17	1/8"	6	5	6	1/8"	14

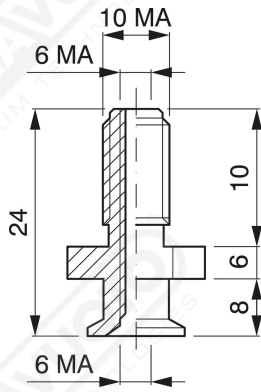

**Art. SUM 36/A\***

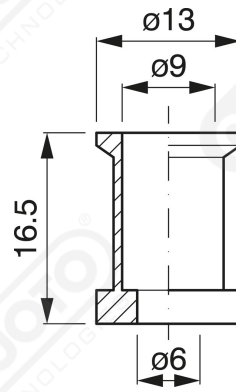

**Art. SUM 36/B\***

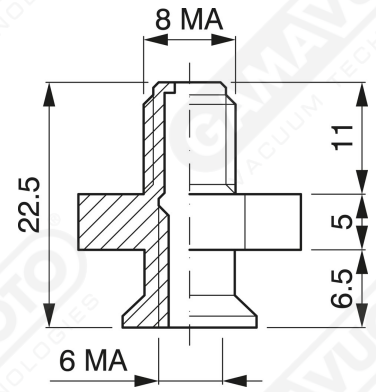

**Art. SUM 36/CA**

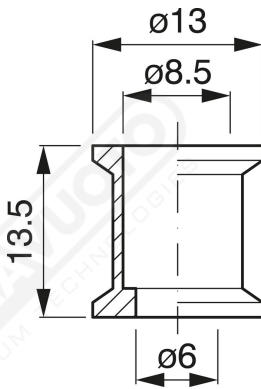

**Art. SUM 36/DA**

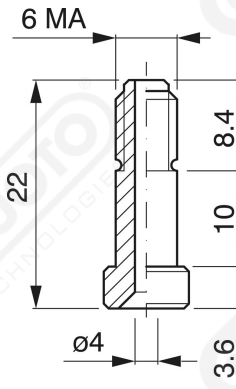

**Art. SUM 36/E\*A**

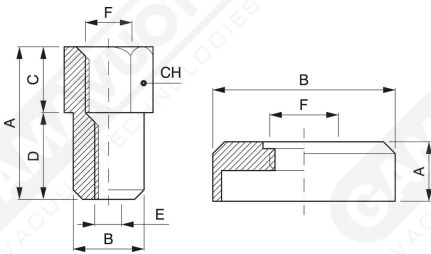

**Art. SUF 51/52/54/57/58/59/63**

Art.	A	B Ø	C	D	E	F	CH
SUF 51	19,5	6 MA	12	7,5	3	1/8"	14
SUF 52	23	11,5	13	10	8 MA	1/4"	19
SUF 54	35	17	15	20	8 MA	1/4"	19
SUF 57	20	8 MA	12	8	3,5	1/8"	14
SUF 58	22,5	12	10,5	12	8 MA	1/8"	14
SUF 59	59	11,5	48	11	8 MA	1/4"	22
SUF 63	14	44	/	/	/	3/8"	/

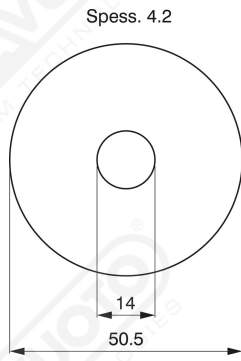

**Art. SUF 55**

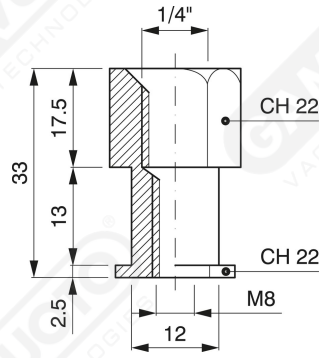

**Art. SUF 60**

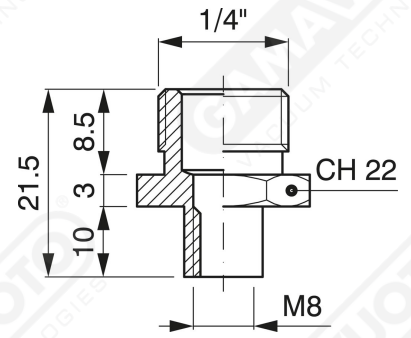

**Art. SUF 62**

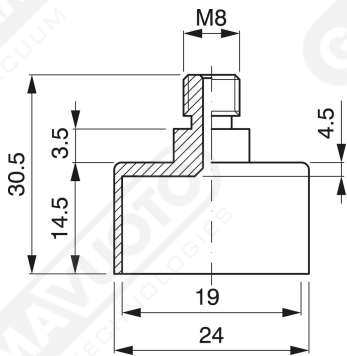

**Art. SUM 54**