

Ventose a soffietto serie VES 48



Le ventose della serie VES sono studiate per essere la soluzione migliore alla movimentazione di sacchetti in plastica e in altri materiali.

Sono composte da due parti separate montate tra loro. Il labbro morbido in silicone garantisce alla ventosa un'ottima presa sulle superfici deformabili, mentre il corpo a più soffietti di maggior durezza garantisce un'ottima resistenza alle sollecitazioni.

Nei supporti disponibili, vi è la possibilità d'integrare un filtro a rete in acciaio INOX e la valvola autoescludente per il controllo flusso del vuoto.

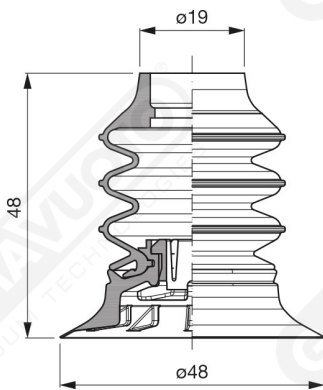

Art. VES 48 35

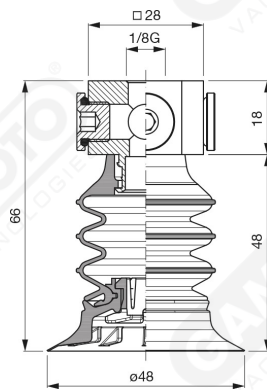

Art. VES 48 00

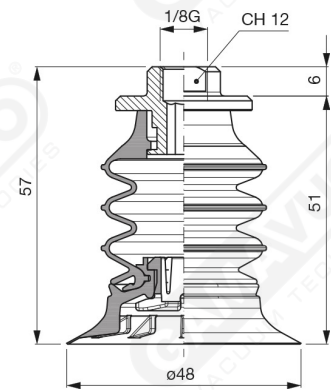

Art. VES 48 20

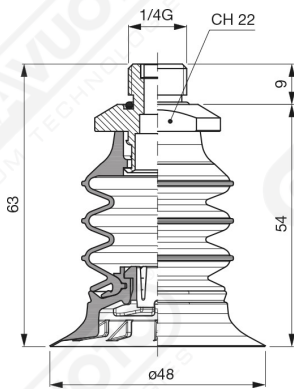

Art. VES 48 70 ÷ 73

Art. VES 48 70

con filtro

Art. VES 48 73

senza filtro

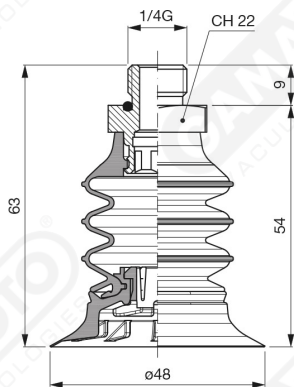

Art. VES 48 74

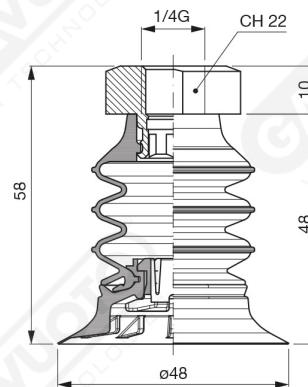

Art. VES 48 76

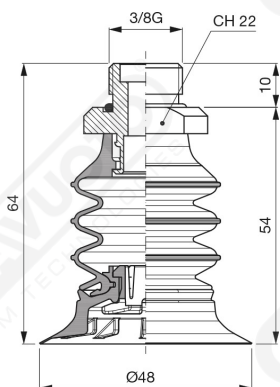

Art. VES 48 80
con filtro

Art. VES 48 83
senza filtro

Art. VES 48 80 ÷ 83

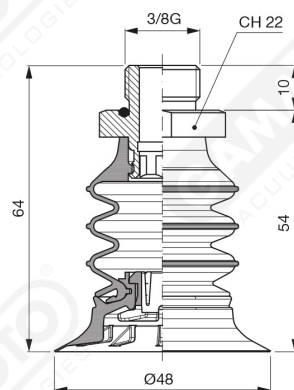

Art. VES 48 84

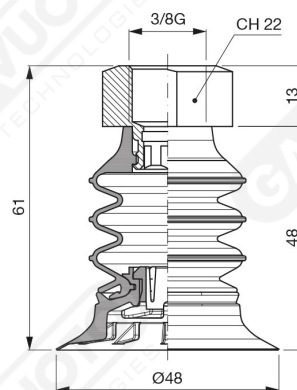

Art. VES 48 86

Ventose F-LINE a soffietto serie VES

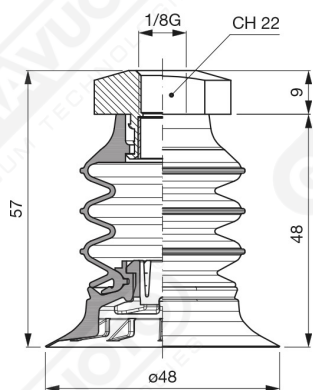

Art. VES 48 90

con filtro

Art. VES 48 93

senza filtro

Art. VES 48 90 ÷ 93

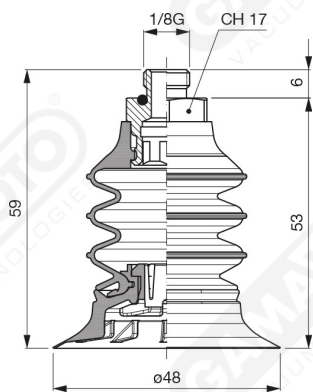

Art. VES 48 94

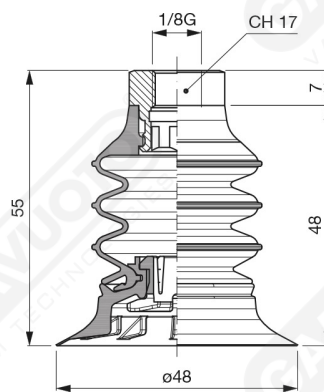

Art. VES 48 96