

## Ventose speciali a soffietto

Special bellow suction cups

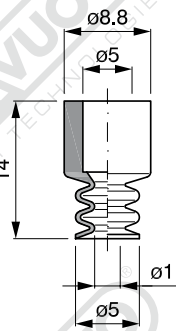

Senza supporto - Without support



art. VSS 5/2

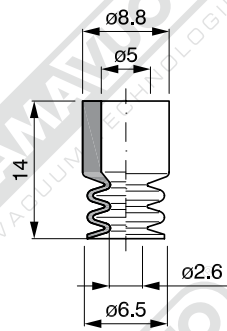

art. VSS 6/2

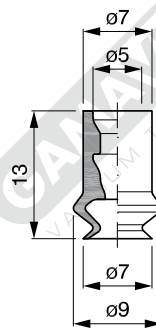

art. VSS 7/1

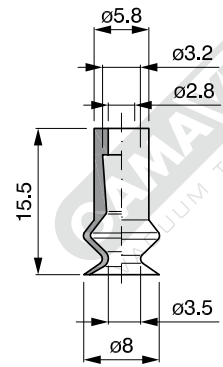

art. VSS 8/1

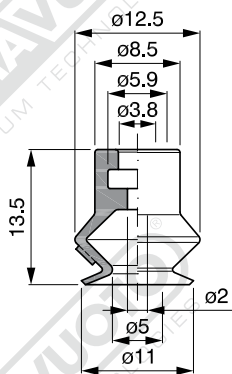

art. VSS 11/1

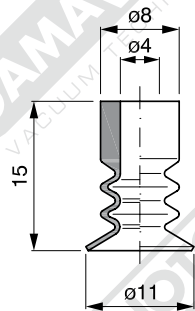

art. VSS 11/2

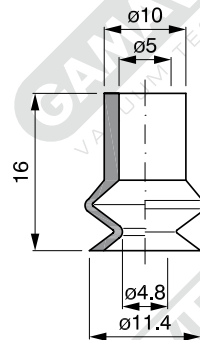

art. VSS 11/3

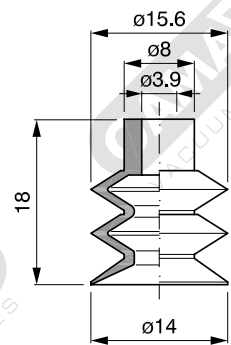

art. VSS 14/2

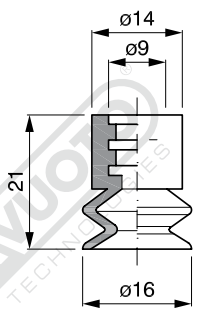

art. VSS 16/1

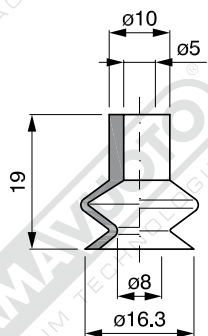

art. VSS 16/3

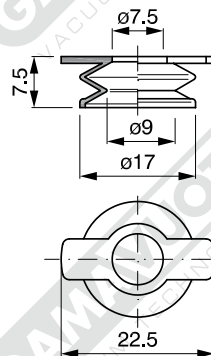

art. VSS 17/1

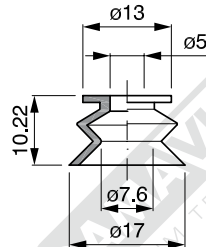

art. VSS 17/2

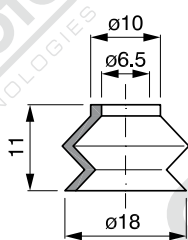

art. VSS 18/1

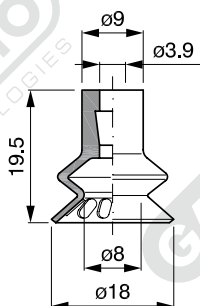

art. VSS 18/3

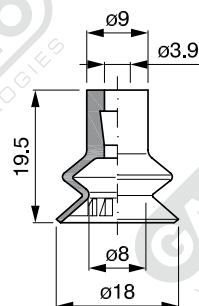

art. VSS 18/4

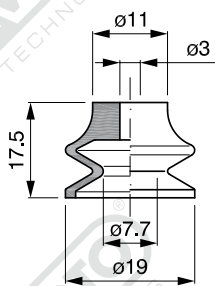

art. VSS 19/1

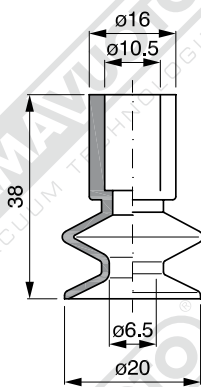

art. VSS 20/1

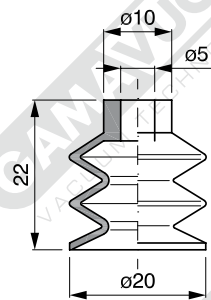

art. VSS 20/2

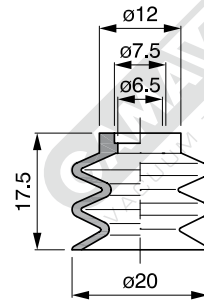

art. VSS 20/3

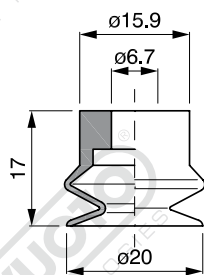

art. VSS 20/4

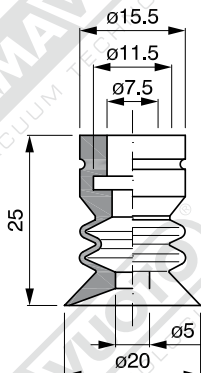

art. VSS 20/5

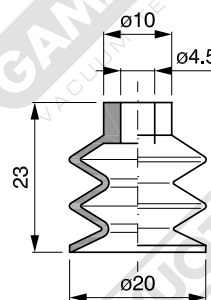

art. VSS 20/6

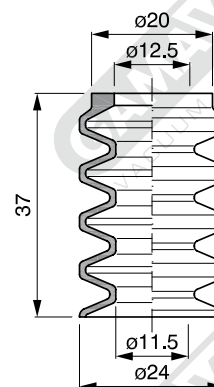

art. VSS 24/4

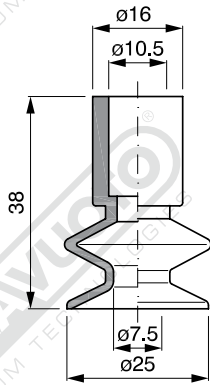

art. VSS 25/1

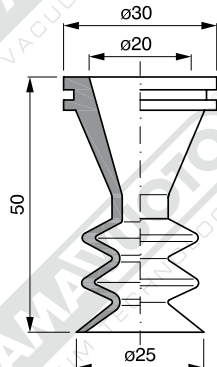

art. VSS25/2

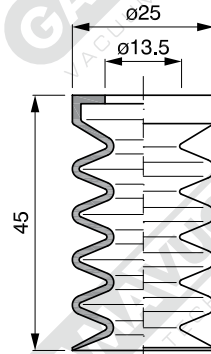

art. VSS 25/4

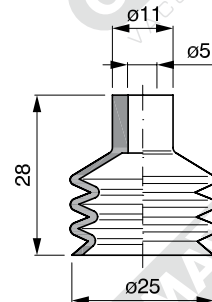

art. VSS 26/3L

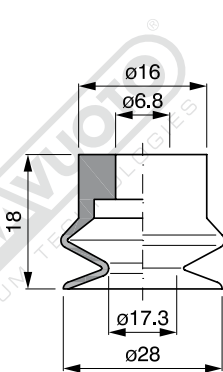

art. VSS 28/1

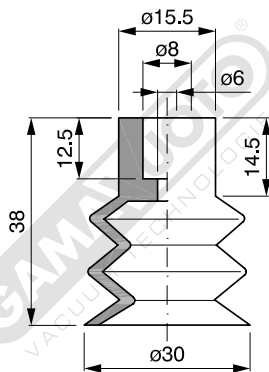

art. VSS 30

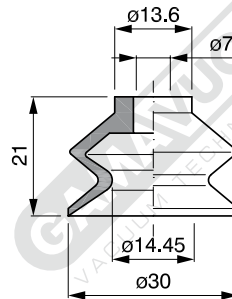

art. VSS 30/1

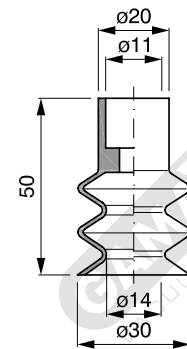

art. VSS 30/2

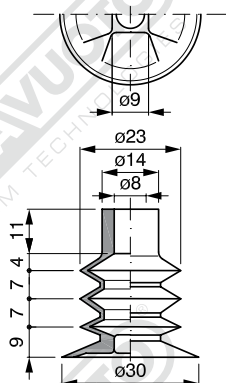

art. VSS 30/3

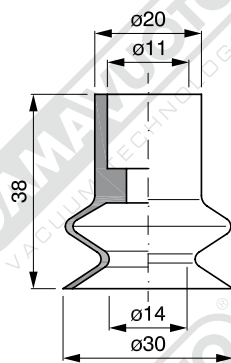

art. VSS 31/1

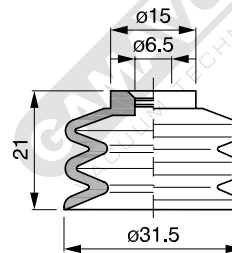

art. VSS 31/2

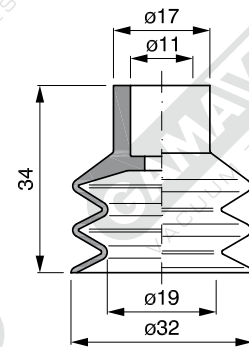

art. VSS 32/1

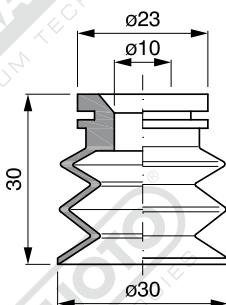

art. VSS 32/2

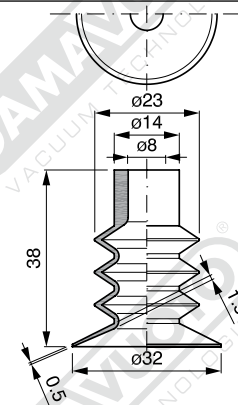

art. VSS 32/3

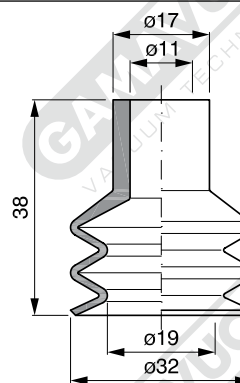

art. VSS 32/4

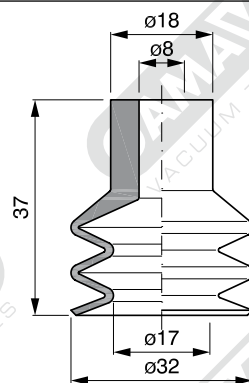

art. VSS 32/5

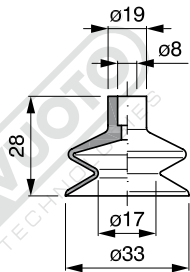

art. VSS 33/1

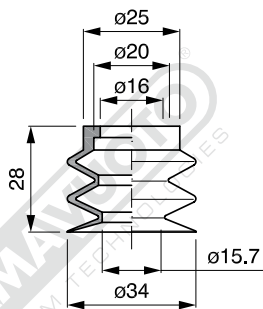

art. VSS 34/1

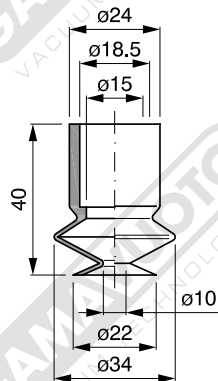

art. VSS 34/3

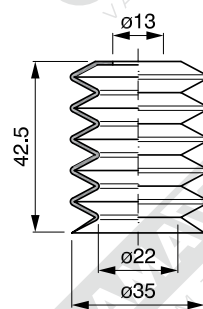

art. VSS 34/5

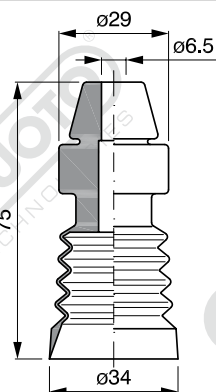

art. VSS 34/6

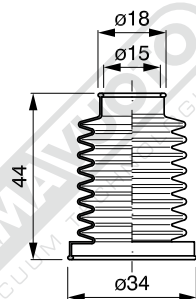

art. VSS 34/8

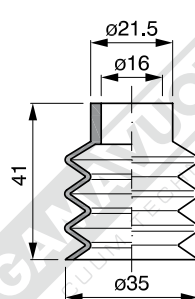

art. VSS 35/3

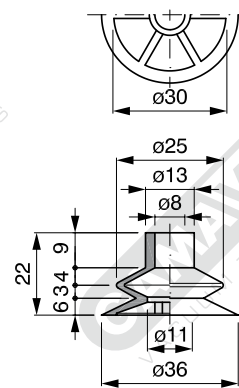

art. VSS 36/1

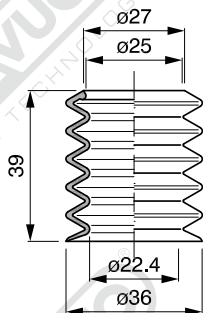

art. VSS 36/5

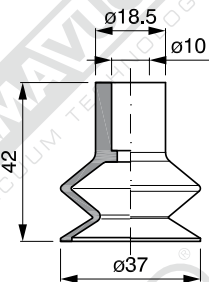

art. VSS 37/1

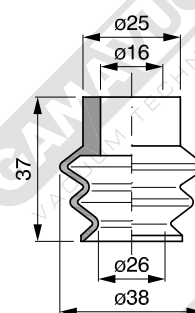

art. VSS 38/2

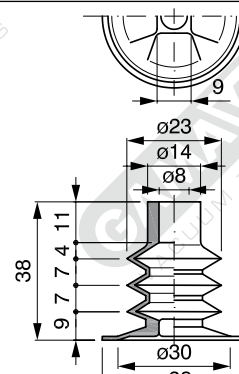

art. VSS 38/3

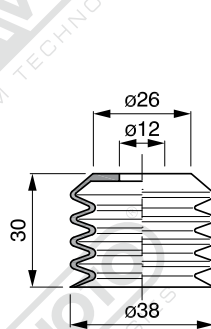

art. VSS 38/4

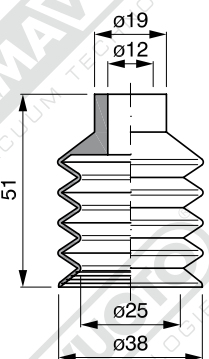

art. VSS 38/4L

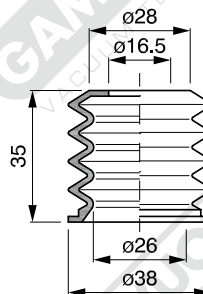

art. VSS 38/5

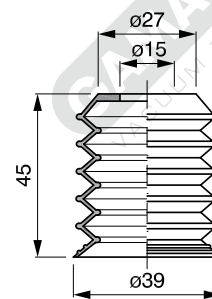

art. VSS 39/5

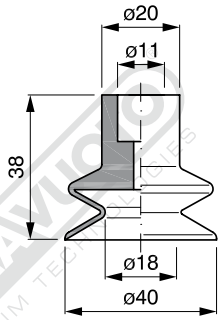

art. VSS 40/1

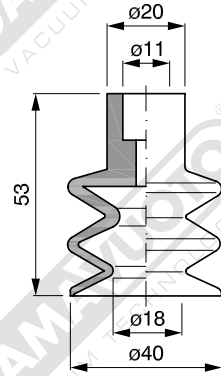

art. VSS 40/2

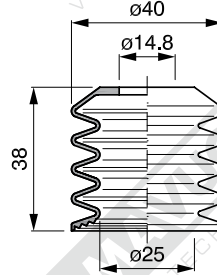

art. VSS 40/4

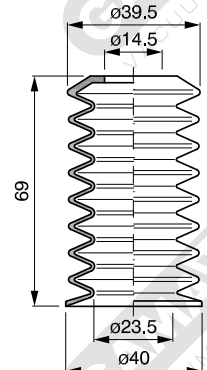

art. VSS 40/8

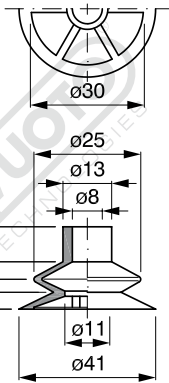

art. VSS 41/1

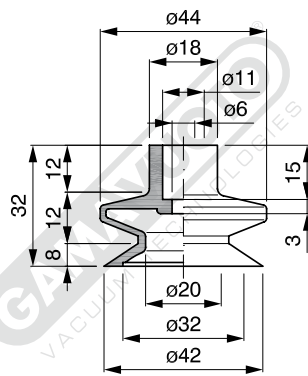

art. VSS 42/1

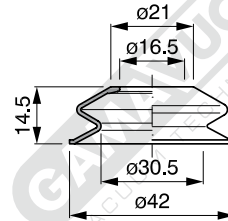

art. VSS 43/1

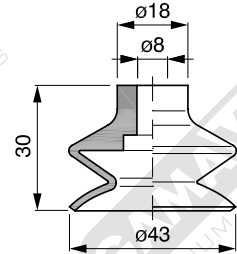

art. VSS 43/11

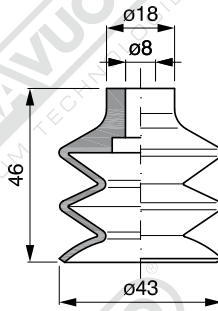

art. VSS 43/3

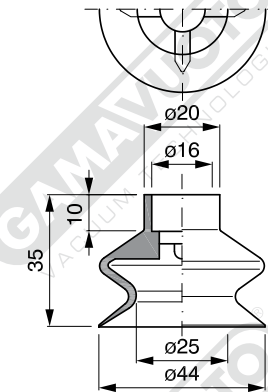

art. VSS 44/1

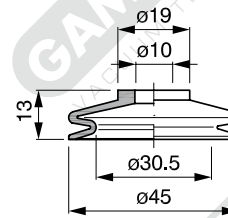

art. VSS 45/1

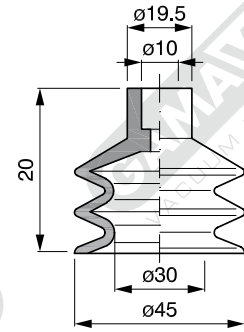

art. VSS 45/2

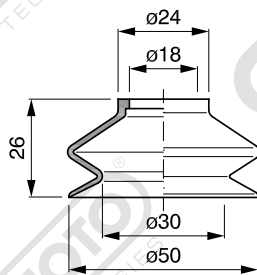

art. VSS 47/1

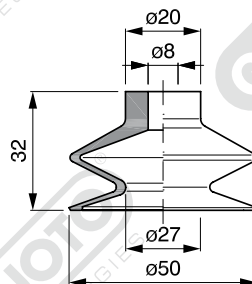

art. VSS 50

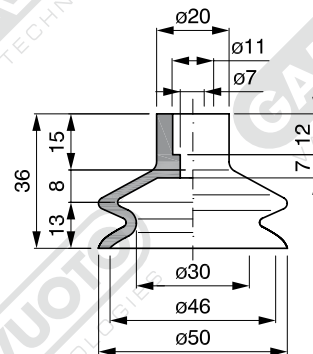

art. VSS 50/1



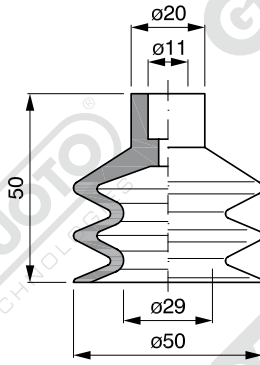

art. VSS 50/2

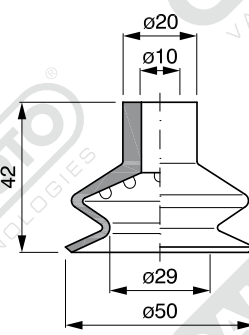

art. VSS 50/3

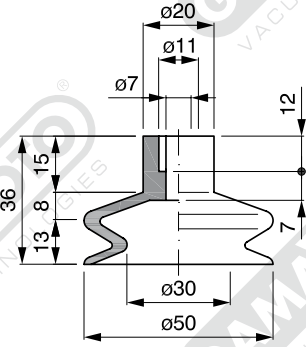

art. VSS 50/4

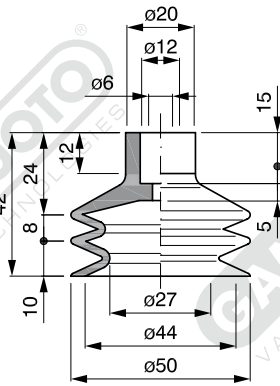

art. VSS 53/2

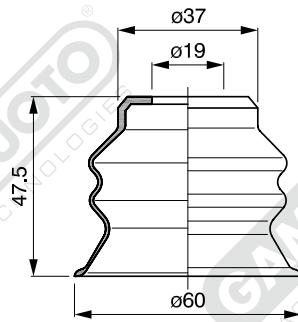

art. VSS 60/1

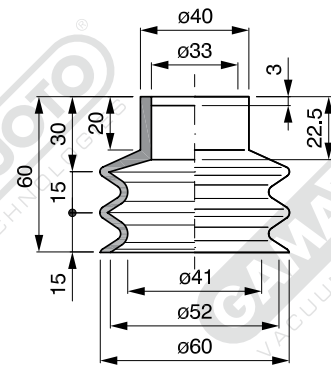

art. VSS 60/2

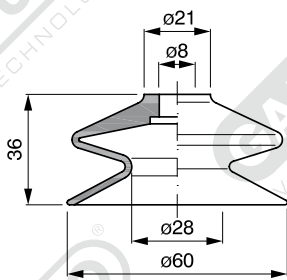

art. VSS 60/11

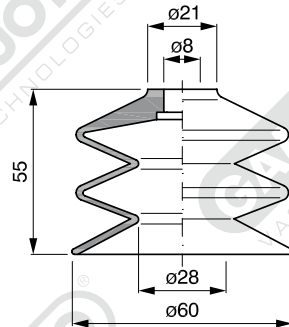

art. VSS 60/12

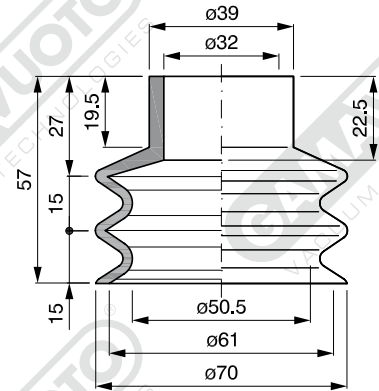

art. VSS 70/2

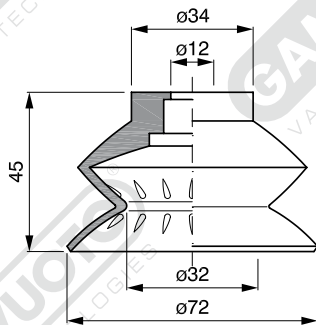

art. VSS 72/1

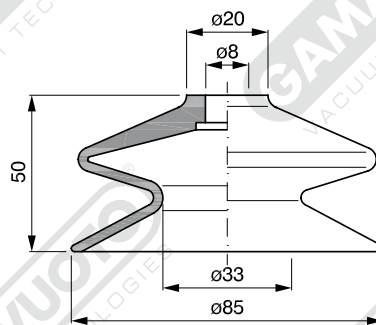

art. VSS 85/11

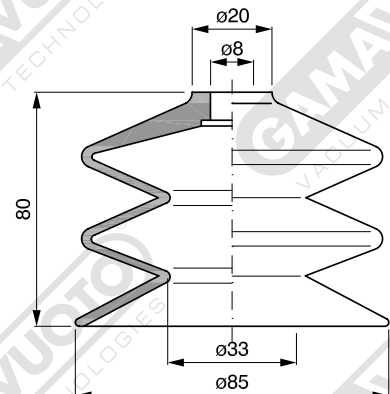

art. VSS 85/12

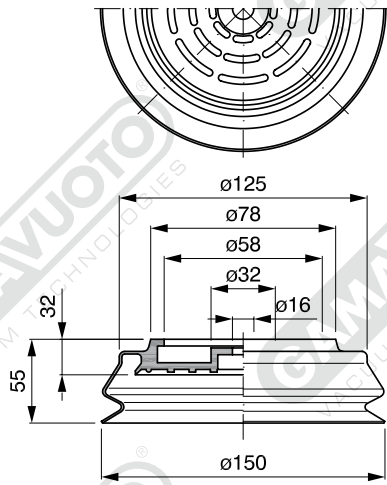

art. VSS 150

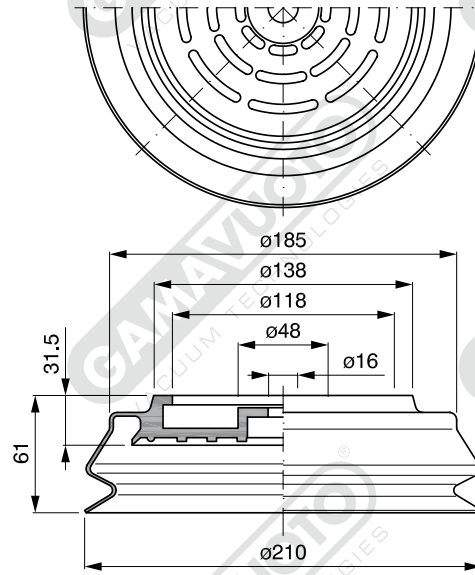

art. VSS 210

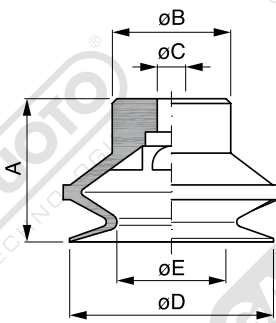

art. VSS

Art.	A	B $\emptyset$	C $\emptyset$	D $\emptyset$	E $\emptyset$
VSS 22	19.5	15	4.5	22	11
VSS 32	30.5	20	6	32.5	17
VSS 43	30	25	6	43	23
VSS 54	36	28	8.5	54	32

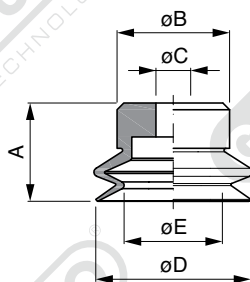

art. VSSP

Art.	A	B $\emptyset$	C $\emptyset$	D $\emptyset$	E $\emptyset$
VSSP 15	11	12	4.5	15	10
VSSP 20	13	15	4.5	20	13
VSSP 30	18	20	6	30	16